

ENGLISH

FLOORIGO INSTALLATION GUIDE

1. Storage and shipping

Make sure that all materials are stored and transported on a level and sturdy surface, laid flat and in neat stacks. Materials should not be stored in extremely cold (temperatures below 2°C) or hot (temperatures above 40°C) conditions or damp environments. (See Figure 1)

2. Prior to installation

Inspect the product: Do the colours match those you ordered; are the quantities correct and is there no visible damage to the packaging?

Acclimatisation: Acclimatisation is not necessary, but the ambient temperature of your job site should be between 18°C and 25°C.

Underfloor heating: If you have underfloor heating, ensure that the floor temperature is between 18°C and 25°C. If you are laying the floor in winter, make sure that the heating system is set to a low temperature from 72 hours before to 72 hours after the installation of your new floor. After laying the floor, be sure to observe the start-up protocol (see Point 5)!

Subfloor: The type of subfloor, its quality and any pre-treatment will have a major impact on the final result. To avoid irregularities in your SPC floor, the substrate must be clean (not contaminated by e.g. oil, wax, paint, etc.) and flat, free of dust, permanently dry and normally porous.

IRREGULARITIES ON A SUBFLOOR MAY NOT EXCEED 4 TO 5 MM MEASURED OVER A WIDTH OF 200 CM.

3. Installation conditions

Take the climatic conditions and the temperature of your job site into account: the ambient temperature must not be below 18°C and the floor temperature not lower than 15°C or higher than 25°C. A constant climate must be maintained from at least 48 hours before until at least 72 hours after laying. Any significant changes in room temperature as part of normal temperature control should be introduced only gradually. While laying the floor, check for any visible defects and do not use any planks or tiles that show imperfections.

Damp areas: The installation of FLOORIGO Click floors is subject to strict rules when installing them in a damp area. The floor is not suitable for installation near a rain shower, for example. Please observe the following rules when installing the floor:

- Use a subfloor that is suitable for SPC and damp areas.
- Take the necessary expansion joints into consideration.
- Do not seal the floor with sealant. This prevents the floor from naturally expanding and shrinking, increasing the risk of shrinkage and expansion seams.

4. Installation and finishing (see Figure 2)

Measure the area where the floor is to be laid and decide how to best to lay the strips.

DUE TO TEMPERATURE FLUCTUATIONS, AN EXPANSION JOINT (BETWEEN 5 - 10 MM) MUST ALWAYS BE MAINTAINED TO PREVENT THE FLOOR FROM WARPING.

Always lay a FLOORIGO Click floor lengthwise in the room (i.e. parallel to the longest wall). Before you start, check if the wall is straight so that the floor can be laid in a properly aligned and straight manner. The floor can then be laid row by row. Make sure that the elements are joined closely together so that the mechanical locking system closes cleanly and tightly. Also ensure that you do not unnecessarily lay many small planks in the areas that will be intensively used, or near doors.

The cut edges of the floor may not be placed under pressure against walls, upright elements and profiles. The floor can be laid continuously on surfaces up to 400 m². To cut plank to size, we recommend using a Stanley knife, starting from the top layer. Cutting the planks to size lengthwise is a bit more difficult with a Stanley knife. Little corners, like the ones you find near door posts and heating pipes, can also be cut to size using a jigsaw. It is best to use a saw for plastic or tiles.

Next, sealant can be used at the entrance and exit doors and adjoining areas.

When laying the floor, make sure that you maintain a distance of 5-10 mm between the edge of the plank and the wall. Corresponding spacers are available for this purpose.

It is best to start laying from the wall outwards.

1. Place the plank at an angle of 20 to 30° against the last plank you laid. Move the plank slightly upwards and downwards, while exerting forward pressure. The planks will click together by themselves.
2. As soon as enough rows have been laid, the floor can easily be finished as follows: place an unopened package of planks on the rows you have already installed. Change position and click the short side of the plank into the last plank you laid.
3. Now put your BOTH hands close to the joint and pull the long side of the plank towards you. The planks will now click together by themselves.

Make sure that the elements are staggered correctly. When laying the last row, the planks must be cut to measure in relation to the wall. A drawbar can be used as a laying aid on the long side. This is, however, not suitable for the short side.

The FLOORIGO Click floors can be laid according to two patterns:

Irregular bond: When laying an irregular bond pattern, the planks should not be laid in uniform sequence, but staggered criss-cross fashion. This method is used quite frequently and produces a beautiful result! The pattern is created by using the cut piece left over at the end of a row as the beginning of the next row. For a stable floor, the plank must have a minimum overlap in order to obtain a good bond. The plank with which you start the next row must be staggered by at least 20-25 cm.

Running bond: The running bond is a pattern in which you alternate whole and half planks, starting with a whole plank. This results in a continuous pattern.

5. Use of the floor

After the floor has been installed, it can be cleaned and used immediately.

Underfloor heating start-up protocol: At least 72 hours after completing the installation of your Die FLOORIGO Click floor, the water temperature can be increased gradually in small steps of 1°C per day until a maximum temperature of 27°C has been reached.

Cleaning after installation: The floor can be cleaned by sweeping, vacuuming or damp wiping using special PVC cleaning products. Always remove any stains e.g. of aggressive substances from the floor immediately!

Protection: Apply proper protection under your furniture. We recommend fitting your furniture with soft caps. Do not use felt, because dirt can accumulate under felt, which can scratch your floor.

Doormat: make sure you have a good doormat; this prevents a lot of dirt on the floor. Don't hesitate to get in touch with us if you need any more advice.

6. Maintenance

FLOORIGO floors are known for their high quality, durability and beauty. In order to retain its beautiful appearance, it is advisable that you maintain your floor properly. Sweep or vacuum your floor regularly, as sand and dirt will scratch the surface of the floor. Mop the floor regularly with lukewarm water, for extra cleaning only use special PVC cleaners. For the best result we recommend you ask your specialist for the correct maintenance products. Do not use chemicals or hard brushes/scouring pads as these will damage the top layer.

Figure 1 - Figur 1 - Figur 1

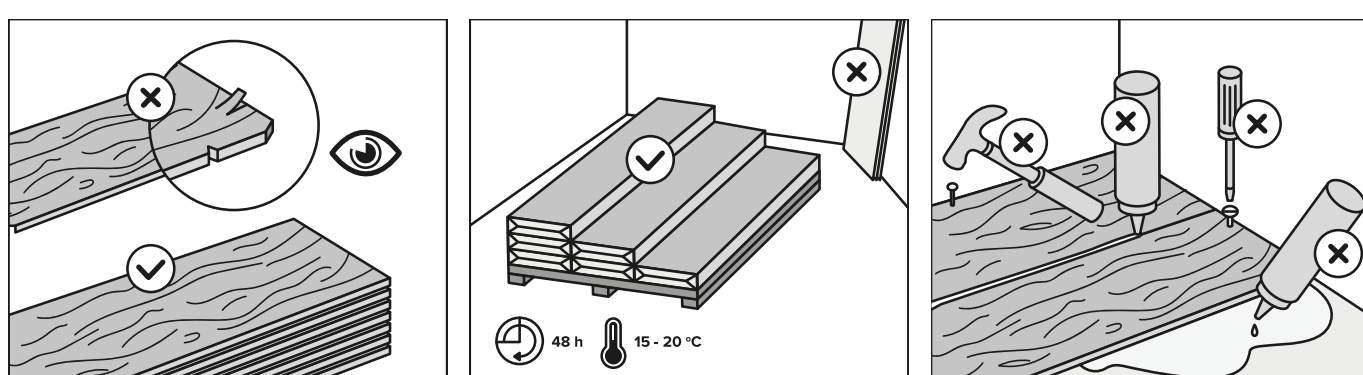

Figure 2 - Figur 2 - Figur 2

